



# Ocean Sensor Systems, Inc.

## Wave Gauge Blue, OSSI-010-022

### A Self Logging/Self Powered Pressure Sensor

#### General Description

The OSSI-010-022 Wave Gauge Blue combines a highly stable Pressure Sensor, a Compact Flash Card Data Logger, a rugged waterproof package and 12 or 28 C size Alkaline Batteries. A Low Power Microprocessor records up to 64 GB of data on a Compact Flash Card in an ASCII format and time and date. The Card is easily removed and can be read on any PC using a standard Compact Flash Card Reader. The Logger will collect months of continuous data or years of burst data. Serial Port and Bluetooth connections are provided as a user interface to configure, monitor and upload small test files. Standard pressure ranges are 1 Bar, 3 Bar and 10 Bar. Optional features include: Up to 16 Pressure Sensors Array, Shore Connection and Water Temperature.

#### Features

- **New** PC Interface Software to Configure, Monitor and Display Raw & Processed Data.
- **New** up to 64GB Compact Flash Card Storage
- **New** Extremely Accurate Real Time Clock  
Maximum  $\pm 2$ ppm
- **New** Programmable, RS232, Wireless Bluetooth
- **New** Optional Features:  
Sensor Array, up to 15 external Pressure Sensors  
Shore Link, RS485  
Water Temperature
- **Flush Hastelloy Diaphragm**, ABS Plastic Housing
- **Power with 12 or 28 C Size Alkaline Batteries**
- **Months to years of Continuous Operation**
- **Sample Rate From 2 Hz to 32Hz**
- **Burst or Continuous Sampling**
- **Accuracy  $\pm 0.05\%$  FS,  $-10^{\circ}\text{C}$  to  $65^{\circ}\text{C}$**
- **Resolution 0.0033% of Full Scale**
- **Long Term Stability  $\pm 0.05\%$ FS**

#### Dimensions and Ordering Information

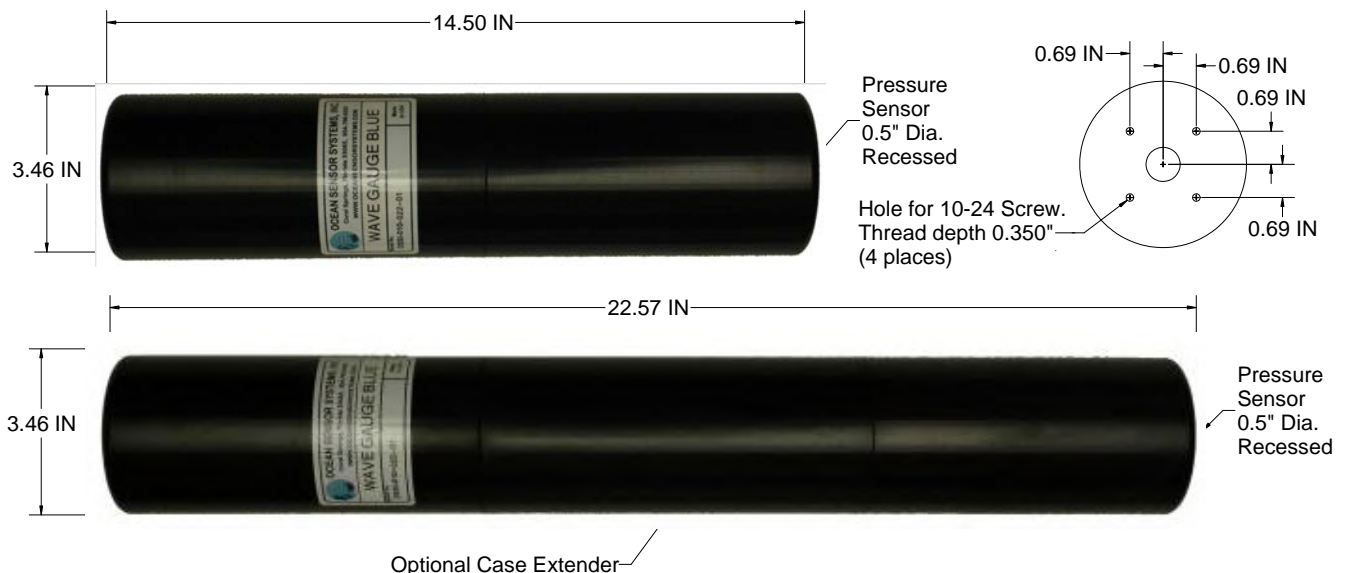

<b>Wave Gauge Blue, OSSI-010-022-</b>		
<b>Pressure Range</b>	<b>Battery</b>	<b>Part Number</b>
0 to 1 Bar	18 volt	OSSI-010-022-01
0 to 3 Bars	18 volt	OSSI-010-022-03
0 to 10 Bars	18 volt	OSSI-010-022-10
0 to 1 Bar Extended Case	21 Volt	OSSI-010-022-01E
0 to 3 Bars Extended Case	21 Volt	OSSI-010-022-03E
0 to 10 Bars Extended Case	21 Volt	OSSI-010-022-10E

Wave Gauge Blue



<b>Options for Wave Gauge Blue, OSSI-010-022</b>			
<b>Optional Features</b>	<b>Add Suffix</b>	<b>Cable length in meters</b>	<b>Number of Additional</b>
Pressure Sensor Array	-P	Sensor to Sensor length	External Sensors
Shore Connection	-S	Wave Gauge to Shore length	
Water Temperature	-W		

Wave Gauge Blue Extended Case



<b>Optional External Pressure Sensors, OSSI-014-</b>		
<b>Case Type</b>	<b>Pressure Range</b>	<b>Part Number</b>
Daisy Chain Case	0 to 1 Bar	OSSI-014-001-01
Daisy Chain Case	0 to 3 Bars	OSSI-014-001-03
Daisy Chain Case	0 to 10 Bars	OSSI-014-001-10
Terminating Case	0 to 1 Bar	OSSI-014-002-01
Terminating Case	0 to 3 Bars	OSSI-014-002-03
Terminating Case	0 to 10 Bars	OSSI-014-003-10

Wave Gauge Blue Array or Shore

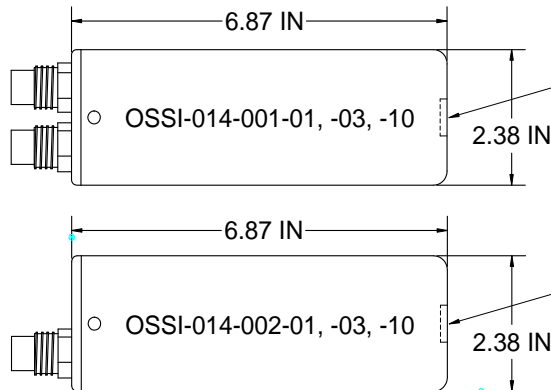

Pressure Sensor  
0.5" Dia.  
Recessed

Pressure Sensor  
0.5" Dia.  
Recessed

PRESSURE SENSOR ARRAY

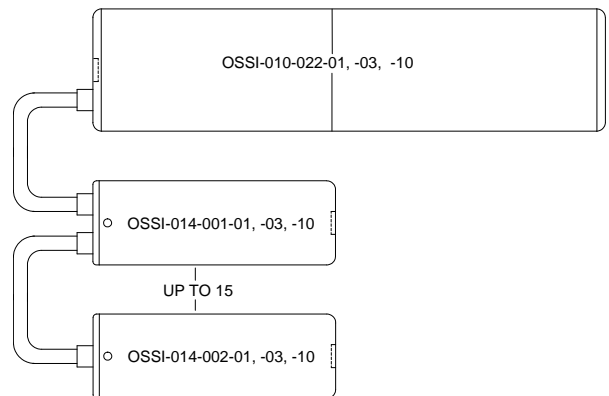

## Electrical Characteristics

Parameter	Conditions	Min.	Typ.	Max.	Units
Battery Voltage	18V, 12 cell battery	9	18	35	VDC
	21V, 28 cell battery (1)	9	21	35	VDC
Battery Drain, Sleep Mode (SI)	Bluetooth Power Off		7.5		mW
	Bluetooth Power On		21		mW
Battery Drain, See Note (2) Continuous Sampling (Fs)	Bluetooth Power Off		70		mW
	Bluetooth Power On		90		
Battery Drain, See Note (2) Connected to a PC	Monitoring Via RS232		82		mW
	Monitoring via Bluetooth		170		mW
Battery Type, See schematic below	Alkaline 18V, 12 C cells		102		Watt hrs
	Alkaline 21V, 28 C cells		238		Watt hrs
Battery Life, Continuous Sampling & Bluetooth Off	18V battery Pack		2.0		Month
	21V battery Pack (1)		4.7		Month
Battery Life, Continuous Sampling & Bluetooth On	18V battery Pack		1.6		Month
	21V battery Pack (1)		3.7		Month
Battery Life, 10% Sample & Bluetooth Power Off	18V battery Pack		10.3		Month
	21V battery Pack (1)		24.0		Month
Battery Life, 10% Sample & Bluetooth Power On	18V battery Pack		5.0		Month
	21V battery Pack (1)		11.8		Month

(1) Note: 21V Battery Pack requires optional extended case.

(2) Note: Add 50mW for each additional External Pressure Sensors.

The 18V 12 alkaline C cells are connected in Series.

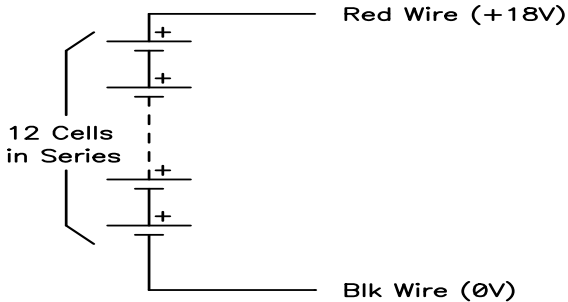

The 21V 28 alkaline C cells are two groups of 14 cells connected in series. Only available with extended Wave Gauge case.

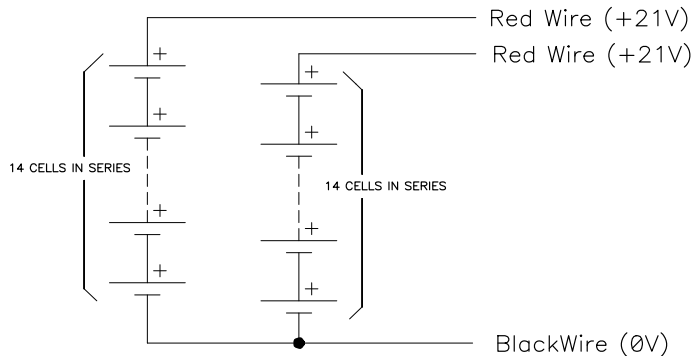

## Data Characteristics, Pressure

Parameter	Conditions	Min.	Typ.	Max.	Units
Pressure Numeric Format & Units	OSSI-010-0022-01			+1.000000	Bars
Pressure Numeric Format & Units	OSSI-010-022-03			+3.000000	Bars
Pressure Numeric Format & Units	OSSI-010-022-10			+9.999999	Bars
Data Accuracy (1)(2)(3)	10 to 40 °C		0.02	0.05	±% FS
Data Accuracy (1)(2)(3)	-10 to 65 °C		0.02	0.1	±% FS
Data Resolution			0.0033		% FS
Long Term Stability	OSSI-010-022-01		0.0005		Bar
Long Term Stability	OSSI-010-022-03, -10		0.05		% FS
Temperature Range	Operating	-10		65	°C

(1) Linearity + Hysteresis + Repeatability + Temperature Coefficients + Zero + Span Tolerance

(2) Accuracy and Resolution are valid for Basic Pressure Range

(3) Linearity: Best Straight Line

## Data Characteristics, Temperature

Parameter	Conditions	Min.	Typ.	Max.	Units
Temperature from Pressure Sensor	Range, -10°C to 65°C	-10.00000		65.00000	°C
	Resolution		0.05		
Water Temperature Sensor	Range	-10		65	°C
	Resolution		0.025		
	Accuracy 0°C to 50°C		0.05	0.1	
	Time Constant		22		Seconds
Sample Capacity, pressure sensor only	2GB Flash Card			76.9	Mega samples
	64GB Flash card			2461	Mega samples
Sample Data Size	First Channel plus Sample Rate		26		Bytes
	Addition Channels		17		Bytes

## Timing and Interfacing Characteristics

Parameter	Conditions	Min.	Typ.	Max.	Units
Sample Frequency	Programmable	2		32	Hz
Serial Baud Rate			115.2		Kbaud
Local Serial Port	Internal via Serial Port Adapter		RS232		Type
Shore Serial Port	Optional External power 10-35V		RS422 or RS485		Type
Bluetooth Serial Port	Wireless Connection		Com-Port		Type
Flash Card Size	FAT16 or FAT32	64		64,000	Mbytes
Sample Burst Time	Programmable	0		59	minutes
Sample Burst Interval	Programmable	1		60	minutes
New File Interval	Programmable	0		255	days
Real Time Clock Accuracy	0°C to 40°C	-2		+2	ppm

### Battery Life Calculation:

Battery life is a function of Burst Time and the Burst Interval. It may be calculated with the following formula.

Calculate Drain power first:  $Dp = Sl + (Fs * (Bt / Bi))$

Where  $Dp$  = Drain power in mW

$Bt$  = Burst Time in minutes

$Bi$  = Burst Interval in minutes

Power used:

$Fs$  = Power used during sampling = See Electrical Characteristics

$Sl$  = Power used during sleep time = See Electrical Characteristics

Now Calculate Battery Life:  $Bl = Bc / Dp$

Where  $Bl$  = Battery Life in Hours

$Bc$  = Battery Capacity in mWhr = 140,000mWhrs typ. for 12 C size alkaline batteries

$Bc$  = Battery Capacity in mWhr = 326,000mWhrs typ. for 28 C size alkaline batteries

$Dp$  = Drain Power in mW

### Estimating Battery Service Life by measuring Battery Pack voltage:

18V Pack Battery with 52mW load and 25°C:

>17.1V = 80% to 100% Service Life remaining

16.4V to 17.1V = 60% to 80% Service Life remaining

16.0V to 16.4 = 40% to 60% Service Life remaining

15.7V to 16.0V = 20% to 40% Service Life remaining

<15.7V = 0% to 20% Service Life remaining

21V Pack Battery with 52mW load and 25°C:

>19.9V = 80% to 100% Service Life remaining

19.1 to 19.9V = 60% to 80% Service Life remaining

18.7V to 19.1 = 40% to 60% Service Life remaining

18.3V to 18.7V = 20% to 40% Service Life remaining

< 18.3V = 0% to 20% Service Life remaining

Battery Life with Bluetooth Power Off

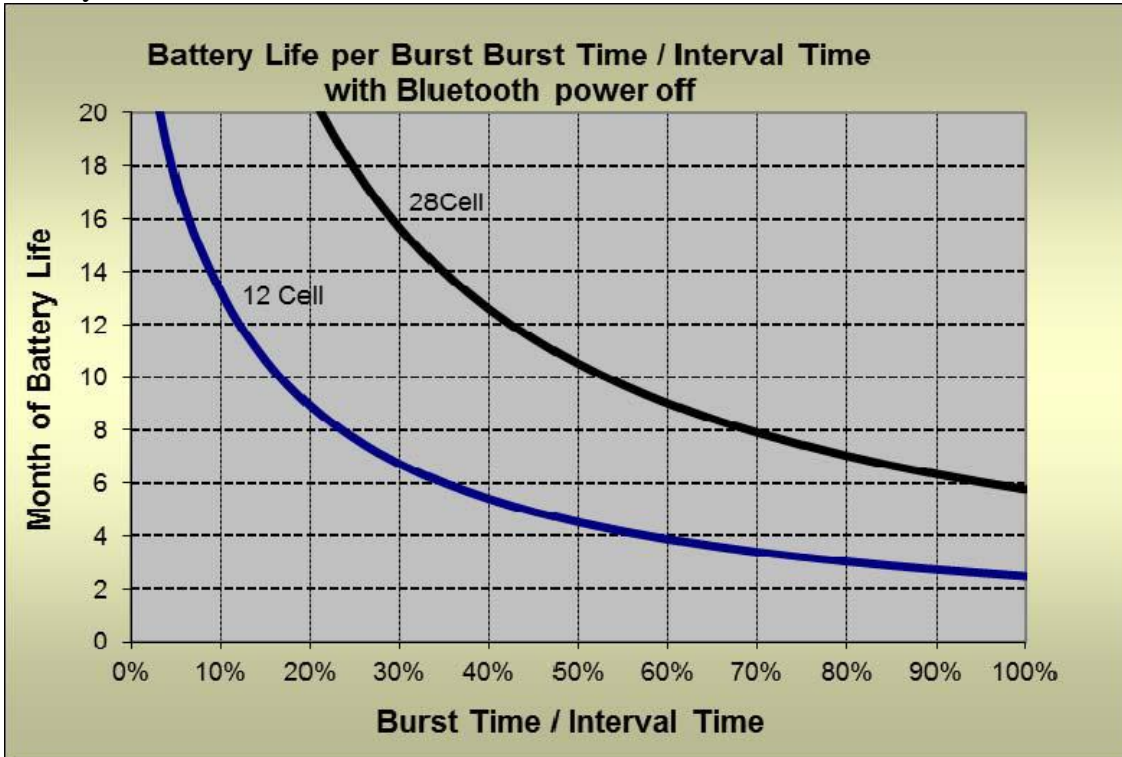

Battery Life with Bluetooth Power On

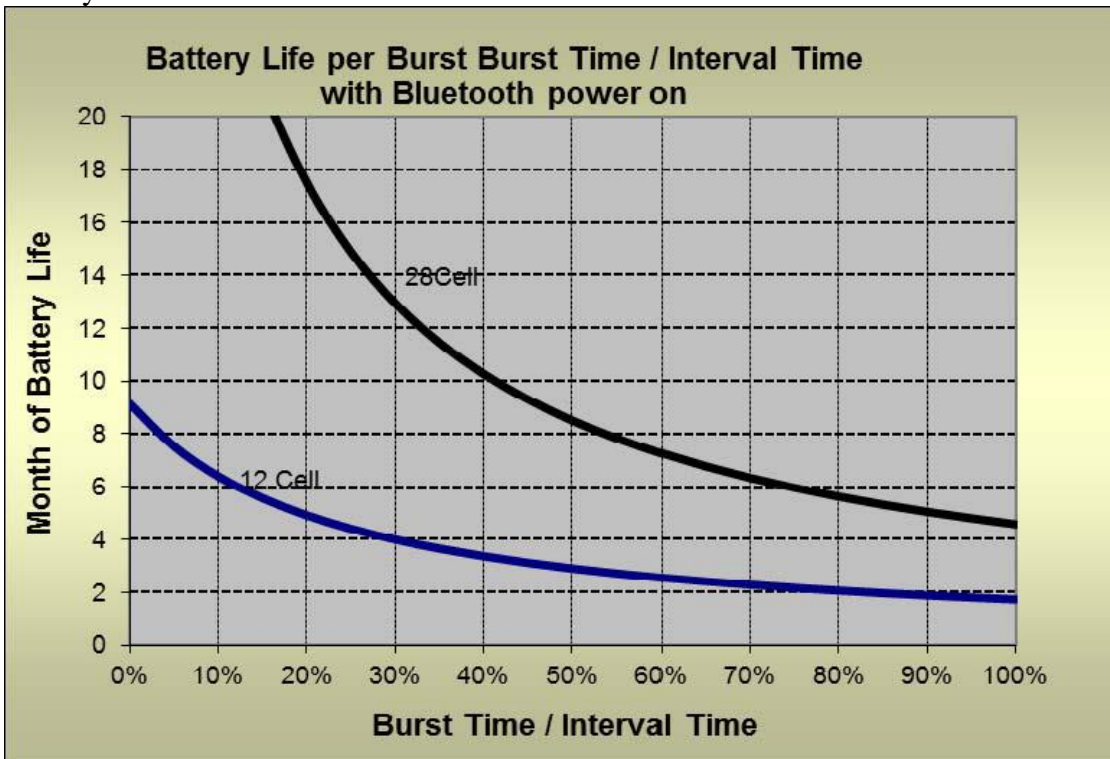



## Data Storage Time:

Data Storage Time is a function of Sample Frequency, Burst Time, Interval and Data format. The number of months of Data Storage for a Compact Flash Card may be calculated with the following formula.

$$Bs = 9 + (17 * Ch)$$

Bs = Bytes per Sample

Ch = Total number of channels enabled.

$$St = (CF / (Bs * F * (Bt / Bi))) / 2,626,560$$

Where St = Storage Time in months

CF = Compact Flash card size in Mbytes

F = Programmed Sample Frequency 2Hz, 4Hz, 8Hz, 16Hz, or 32Hz

Bt = Burst Time in minutes

Bi = Burst Interval in minutes

2,626,560 = Seconds per month

### Example: 2G byte Compact Flash card with one channel sampled:

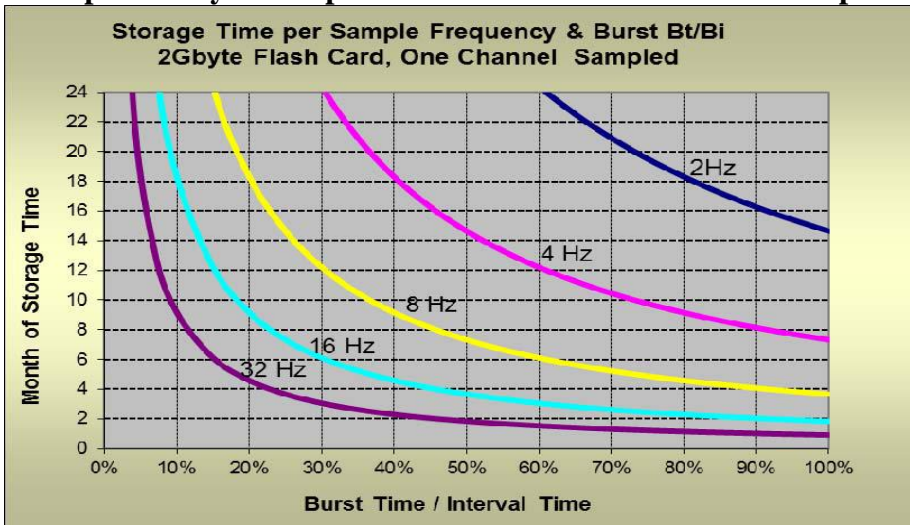

### Example: 8G byte Compact Flash card with six channels sampled:

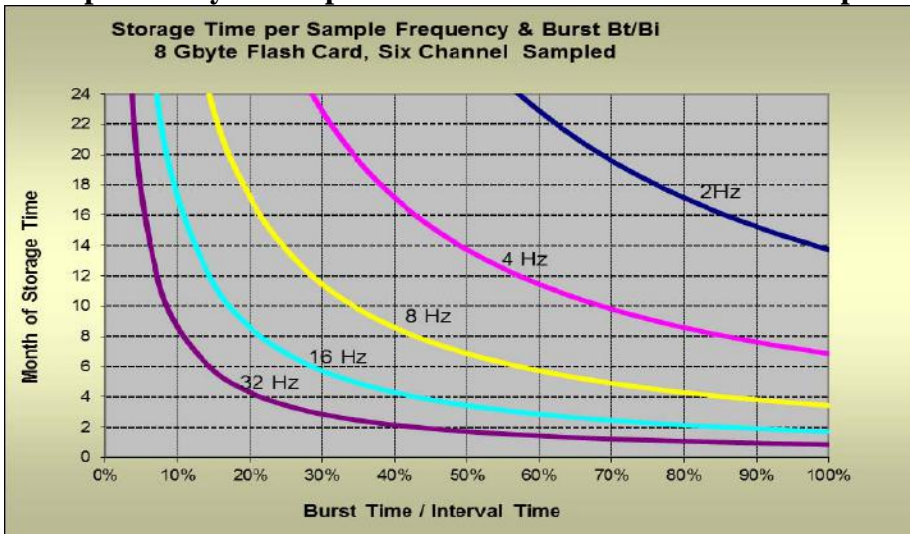

### **Number of Files and File Name:**

A new directory will be created each time the power is cycled or the flash card is replaced. The maximum number of new files in the directory is 9999, 1 per day or less. The file names are automatically created starting at WGBL0001 and sequenced up to WGBL9999.

### **File Format:**

A File Header is placed at the start of each file when created. The Header contains the Wave Gauge Blue version, Part number, time, date and configuration information. Each line starts with a blank space and the last line ends with an additional carriage return line feed.

### **Example File Header:**

```
Wave Gauge Blue Ver,1,  
Part #,OSSI-010-022A-3-WES  
Serial #,YY-MM-DD-000  
Date & Time,2013-01-05T10:43:47  
Sample Rate,8,Hz  
Burst Length,Continuous  
Burst Interval,3,Min.  
New File Interval,Continuous
```

```
D1,C8,2013-01-05  
D1,C9,10:44:00  
D1,C0,8  
D1,C1,+0.012034
```

### **File Data Format:**

The Time and Date are placed at the start of the stored data and at each new Burst Interval. The Sample Rate is inserted in the stored data at the start of each sample period. Each line of data represents one data type. The data type is determined by the Device Number and the Channel Number. Example: D2,C1,+0.012034 is Device Number 2 and the Channel Number 1.

D1 = Wave Gauge Blue  
D2 – D15 = External Pressure Sensors

C0 = Sample Rate in Hz  
C1 = Pressure Sensor data in bars  
C4 = Temperature of the Pressure Sensor data in °C  
C6 = Optional Water Temperature Sensor data in °C  
C7 = Battery warnings  
C8 = Date ISO 8601 UTC: YY-MM-DD  
C9 = Time ISO 8601 UTC: hh:mm:ss

Example:

```
D1,C8,2013-01-05  
D1,C9,21:10:00  
D1,C0,8  
D1,C1,+0.010887  
D1,C4,+25.73291
```



D1,C6,+23.10306  
D2,C1,+0.025031  
D1,C0,8  
D1,C1,+0.010894  
D1,C4,+25.73291  
D1,C6,+23.01542  
D2,C1,+0.025035

## **Array Sample Timing Variations:**

### **Sequence of sampling for each sample period: (Example Wave Gauge Blue Plus 4 External Pressure Sensors)**

1<sup>st</sup> Data is retrieved and logged from the Wave Gauge Blue Pressure sensor. Data may be up to 10 mS old. (Note 1)

2<sup>nd</sup> 7.8125125 mS later data is retrieved and logged from the first External Pressure Sensor. Data may be up to 10 mS old.

3<sup>rd</sup> 7.8125 mS later data is retrieved and logged from the second External Pressure Sensor. Data may be up to 10 mS old.

4<sup>th</sup> 7.8125 mS later data is retrieved and logged from the third External Pressure Sensor. Data may be up to 10 mS old.

5<sup>th</sup> 7.8125 mS later data is retrieved and logged from the forth External Pressure Sensor. Data may be up to 10 mS old. (See note 2, number of sensors)

### **Notes:**

Note 1: If the 7.7125 mS delays are accounted for the sample time variations from sensor to sensor is limited to 10mS (Note 3).

Note 2: The Wave Gauge Blue Sample Rate is the frequency that serial data is retrieved and logged from each sensor. The maximum Sample Rate is limited by the number of sensors selected. A Sample Rate of 32Hz is limited to 4 Pressure Sensors (3 external sensors plus the Wave Gauge Blue sensor). 16Hz is limited to 8 Pressure Sensors (7 external sensors plus the Wave Gauge Blue sensor) and 8Hz or less is limited to 16 Pressure Sensor. The total number of Pressure Sensors times the Sample Rate must be equal to or less than 128.

Note3: Each Pressure Sensors **independently** preforms pressure conversions at a rate of at least 100 operations per second. Their sample frequencies are not synchronized to each other.

## Communications and Configurations:

A new, easy to use, Wave Gauge Blue Interface Program is available to download from our web site. We recommend using the program to configure the Wave Gauge Blue for your particular requirements. It can also be used to monitor and display raw and processed wave data or even upload small test files.

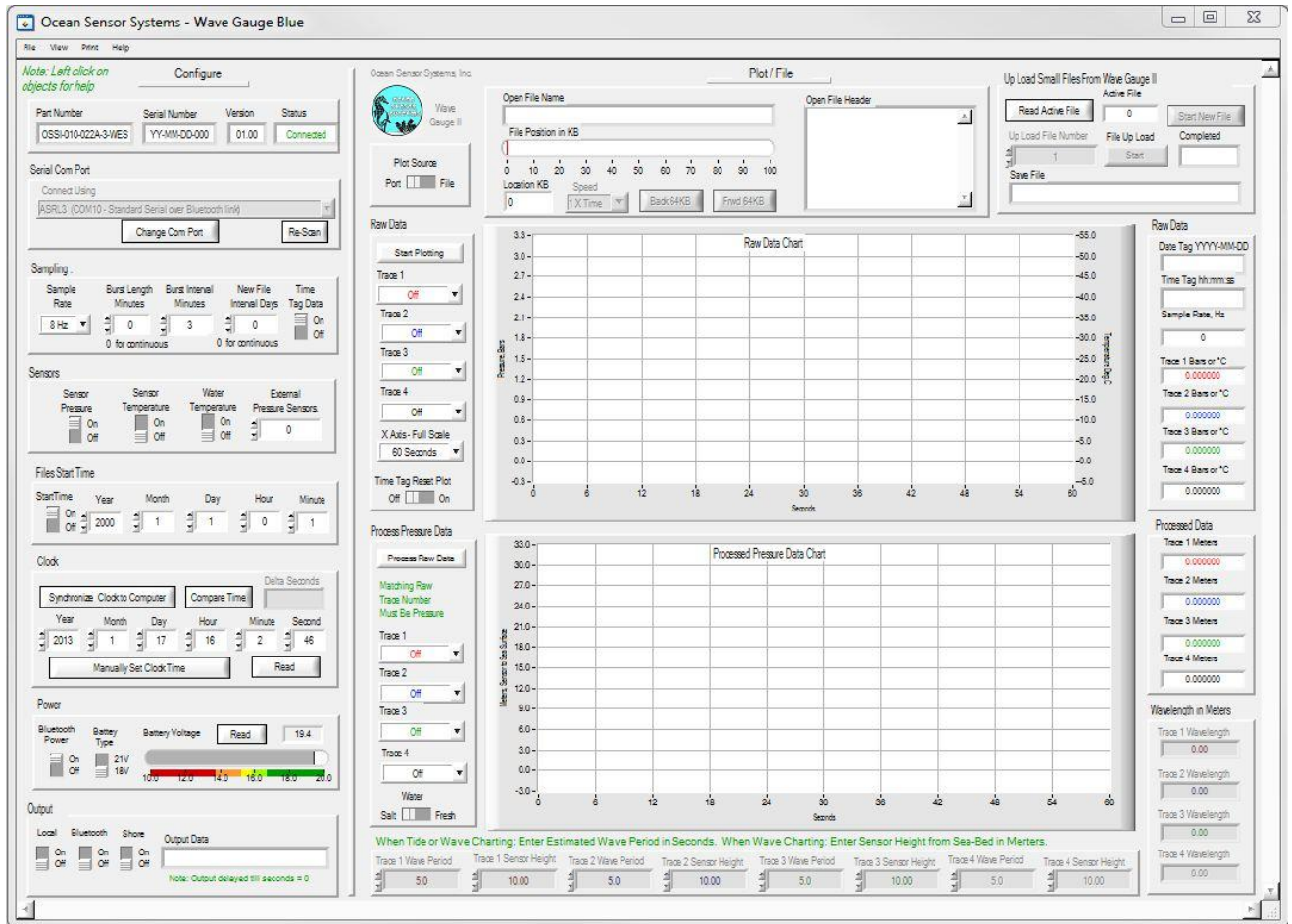

There are several methods that the PC can link to the Wave Gauge Blue. An internal RS232 Port is provided which can be connected to the PC using the Serial Interface Cable. A wireless Bluetooth connection may also be used to connect the Interface Software to the Wave Gauge Blue. A third method is via the optional Shore Connector.

After selecting the correct serial COM port a connection to the Wave Gauge Blue will be attempted automatically. If successful the status indicator will display Connected with green letters and all of the Wave Gauge Blue's configuration settings will be displayed. To change the Wave Gauge Blue's configuration simply change a value on the display. The Wave Gauge Blue will be automatically updated to the new value.

The Wave Gauge may also be configured with a program such as Hyper Terminal. The following is a list of commands. Entering "help" will display the command list. The port setting should be 115.2Kbaud, Data Bits 8, Parity None, Stop Bits 1 and Flow Control None.

**Read Commands:**

Enter RH to read the Part number  
Enter RK to read the Software version  
Enter RD to read the Serial number  
Enter RS to read the Sample Rate  
Enter RL to read the Burst Length  
Enter RI to read the Burst Interval  
Enter RF to read the New File Interval  
Enter RX to read the number of External Sensors Configuration  
Enter RB to read Bluetooth Device Power Enable Status (1=yes 2=no)  
Enter RE to read Internal Sensor Enable Status (1=yes 2=no)  
Enter RG to read Time Tag Enable Status (1=yes 2=no)  
Note: Time Tag rate will be per Burst Interval Rate  
Enter RR to read Start Time Enable Status (1=yes 2=no)  
Enter RC to read Temperature Sensor Enable Status (1=yes 2=no)  
Enter RW to read Water Temperature Enable Status (1=yes 2=no)  
Enter RT to read the Time and Date (YY-MM-DDThh:mm:ss)  
Enter RQ to read the Start Time and Date minus 1 minute (YY-MM-DDThh:mm)  
Enter RV to read the Battery Voltage  
Enter RP to read the Present File Number  
Enter RM to read Output Local Enable Status (1=yes 2=no)  
Enter RN to read Output Bluetooth enable status (1=yes 2=no)  
Enter RO to read Output Shore Enable Status (1=yes 2=no)  
Enter RZ to read Time & Date Sync to Second (YY-MM-DDThh:mm:ss)

**Write Commands:**

Enter WZ,? to Enable/Disable Text Interface(1=on & 2=off)  
Enter WS,?? to write the Sample Rate (1,2,4,8,16 or 32 Hz)  
Enter WL,?? to write the Burst Length (1 to 59 Minutes, 0 for Continuous)  
Enter WI,?? to write the Burst Interval (1 to 60 Minutes)  
Enter WF,??? to write the New file Interval (1 to 255 Days, 0 for Continuous)  
Enter WX,?? to write new number of External Sensor Device(1 to 15)  
Enter WE,? Internal Sensor Device enabled (1=yes & 2=no)  
Enter WB,? Bluetooth Transceiver enabled (1=yes & 2=no)  
Enter WG,? to write Time Tag enabled (1=yes & 2=no)  
Enter WR,? to write Start Time enabled (1=yes & 2=no)  
Enter WC,? Sample Temperature of Pressure Sensor (C4) Degs, C (1=yes & 2=no)  
Enter WW,? Sample Water Temperature (C6) Degs C (1=yes & 2=no)  
Enter WT,YY-MM-DDThh:mm:ss to write New Time and Date  
Enter WQ,YY-MM-DDThh:mm to write New Start Time and Date  
Enter WP,? to close Present File and start a New File!(1=yes & 2=no)  
Enter WA,?? to write New Device Address to the Pressure Sensor(1 to 16) Note: No External Sensor or 1 External Sensor with Internal Sensor disabled  
Enter WD,FD to write factory Default Configuration (Port Baud Rates not changed)

**Output Data Commands:**

Enter OP,?? to output last sample for Device number(1-16)  
Enter OL,? Local Output Device Data (1=yes & 2=no)  
Enter OS,? Shore Output Device Data (1=yes & 2=no)  
Enter OB,? Bluetooth Output Device Data, Bluetooth must be enabled(1=yes & 2=no)

Enter OF,?,???? to output file number (1=Cont., 2=512CRC 3=ReSendCRC and 4=Cancel),(0001 - 9999)  
Enter OI,???? to read a file size(0000-9999)

**The followings commands are for factory and experienced user only!!**

Enter BL,?? to change the Local Baud Rate (9=9600 baud & 11=115200 baud)  
Enter BS,?? to change the Shore Baud Rate (9=9600 baud & 11=115200 baud)  
Enter BB,?? to change the Bluetooth Baud Rate, Bluetooth must be enabled(11=115200 baud & 46 = 460800 baud)  
Enter BD,CB to change all Devices Baud from present baud  
Enter BU,UB to update to New Baud settings  
Enter BC,CP to Cycle Sensor Device Power and set Baud Rate  
Enter LB to link Local to Bluetooth Device ESC to quit, Bluetooth must be enable  
Enter LP to link Local(9600Baud)to Pressure Sensor(9600Baud)ESC to quit, Prog30

**Pressure Sensor Device Number and RS485 Address:**

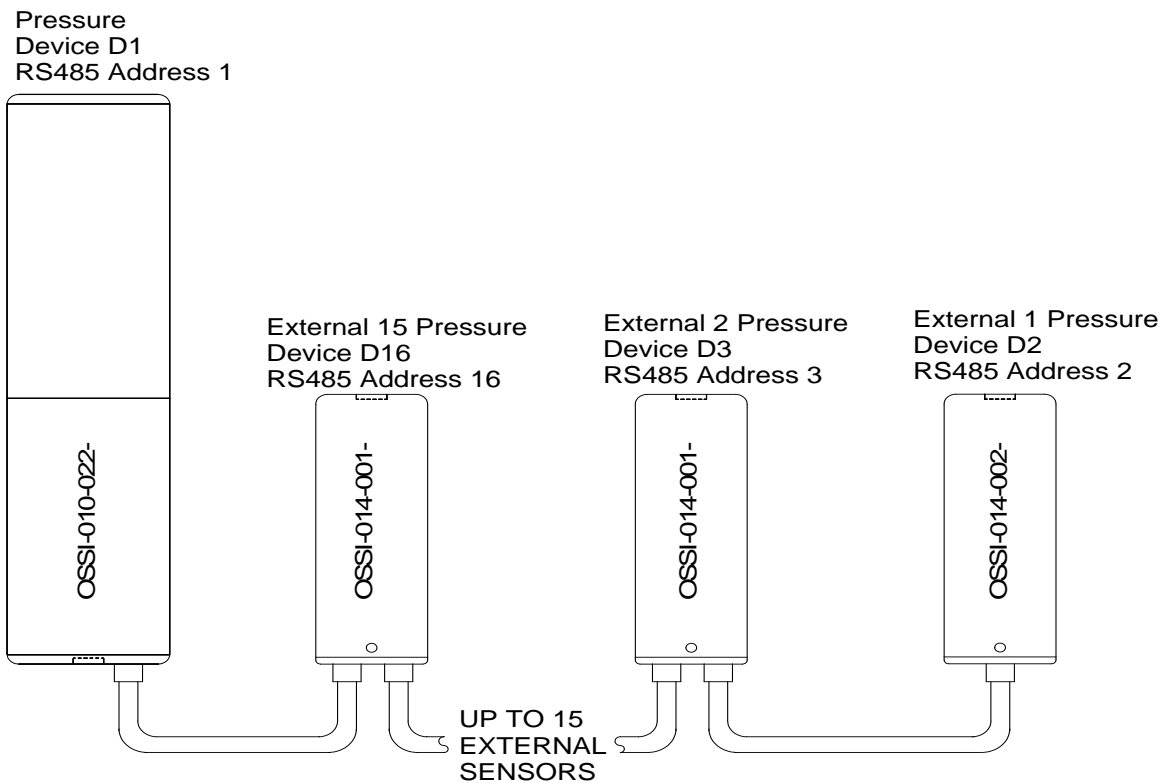

**Changing the External Pressure Sensor RS485Address:**

To change an External Pressure Sensor address (device number), disconnect all other External Pressure Sensors. Set Internal Sensor Device enabled to “no” (WE,2) and number of External Sensor Devices to “1” (WX,1). This configuration uses the broadcasting address number 0. Now write the new device address to the Pressure Sensor 2 thru. 16 (WA,??).

**Installing and Removing the Compact Flash card:**

Install the Compact Flash card with the top label facing down as viewed below. If the power plug is connected, the File Status LED will turn on for 3 seconds. If the power plug is not connected, the File Status LED will turn on for 3 seconds when it is connected. If the card size

or format is incorrect, the File Status LED will blink fast. If the battery voltage is low the LED will not turn on.

To remove the card, **first press the Close File Button**. The File Status LED will indicate that it is ok to unplug the card by a continuous 1 second on and 1 second off blinking. The File Status LED will stop blinking when the card is removed. If the card is removed before pressing the Close File Button **the last file may be corrupted**. The File Status LED will blink fast to indicate this error.

